

## Gas Discharge Tubes (GDT)

## SMD2921 Series

### Description

Gas discharge tubes (GDT) use noble gasses enclosed in ceramic tubes to provide an alternate circuit path for voltage spikes. The ceramic envelope and with nickel connectors allow for high loads. SMD2921 Gas Discharge Tubes (GDT) series has a surge rating of 1kA, 8/20 $\mu$ s. Offered in a Squared Surface Mount package, which helps to make pick and place on PCB process easier.

This GDT series is perfectly suited for broadband equipment applications. The GDT's low off-state capacitance is compatible with high bandwidth applications and this capacitance loading value does not vary if the voltage across the GDT changes.

SMD2921 Gas Discharge Tube (GDT) series are specifically designed for protection of electrical, multimedia, and communication equipment against over voltage transients in surface mount assembly applications.

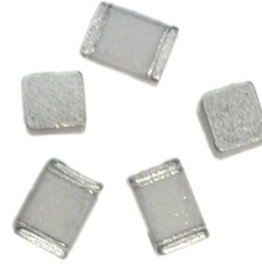

### Electrical symbol

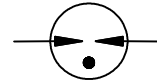

### Features

- I Excellent response to fast rising transients
- I Stable breakdown voltage
- I GHz working frequency
- I 8/20 $\mu$ s Impulse current capability: 1KA
- I Surface Mount package
- I Non-Radioactive
- I Ultra Low capacitance(<0.5pF) and insertion loss
- I Very small size: 2.9mm\*2.1mm\*1.9mm
- I Storage and operational temperature: -40~+125°C

### Applications

- I Communication equipment
- I CATV equipment
- I Test equipment
- I Data lines
- I Power supplies
- I Telecom SLIC protection
- I Broadband equipment
- I ADSL equipment, including ADSL2+
- I XDSL equipment
- I Satellite and CATV equipment
- I General telecom equipment

### Part Number Code

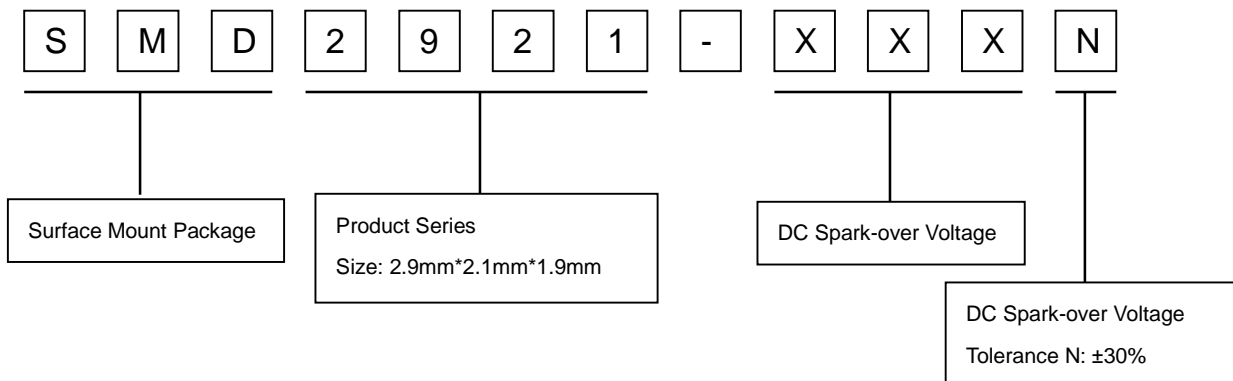

## Gas Discharge Tubes (GDT)

## SMD2921 Series

### Electrical Characteristics

Part Number	DC Spark-over Voltage <sup>1) 2)</sup> @100V/S	Impulse Spark-over Voltage		Insulation Resistance <sup>3)</sup>	Capacitance @1MHz	Glow Voltage @10mA	Arc Voltage @1A	Life Ratings <sup>4)</sup>		
		100V/μS	1KV/μS					Impulse Discharge Current @8/20μS	Impulse Withstanding Voltage Capacity @10/700μS, 40W	Impulse Life @10/1000μS
		Max	Max							
		V	V					V	GΩ	pF
SMD2921-090N	90±30%	500	600	1	0.5	60	10	1	6	10
SMD2921-120N	120±30%	500	600	1	0.5	60	10	1	6	10
SMD2921-150N	150±30%	500	600	1	0.5	60	10	1	6	10
SMD2921-200N	200±30%	600	700	1	0.5	60	10	1	6	10
SMD2921-230N	230±30%	600	700	1	0.5	60	10	1	6	10
SMD2921-300N	300±30%	700	800	1	0.5	60	10	1	6	10
SMD2921-350N	350±30%	800	900	1	0.5	60	10	1	6	10
SMD2921-400N	400±30%	850	950	1	0.5	60	10	1	6	10
SMD2921-470N	470±30%	900	1000	1	0.5	60	10	1	6	10
SMD2921-600N	600±30%	1100	1200	1	0.5	60	10	1	6	10
Glow to Arc transition Current.....					<0.2A					
Weight.....					~0.08g					
Operation temperature .....					-40~+125°C					
Recommended storage <sup>5)</sup>										
- Temperature .....					+5~+35°C					
- Humidity .....					45~+80%					
- Period.....					≤ 2 years					
Climatic category (IEC 60068-1).....					40/125/21					
Marking.....					Without					
Surface treatment.....					Matte-tin plated					
Moisture sensitivity level <sup>6)</sup> .....					1					

<sup>1)</sup> At delivery AQL 0.65 level II, DIN ISO 2859.

<sup>2)</sup> In ionized mode.

<sup>3)</sup> Insulation Resistance Measuring Voltage: nominal voltage 90~150V at DC 50V, others at DC 100V.

<sup>4)</sup> Tests according to ITU-T K.12 and UL 497B.

<sup>5)</sup> Specified in terms of corrosion against tin plating.

<sup>6)</sup> Tests according to JEDEC J-STD-020.

Terms and current waveforms in accordance with ITU-T K. 12, IEC61643-21 and IEC 61643-311.

## Gas Discharge Tubes (GDT)

## SMD2921 Series

### Dimensions

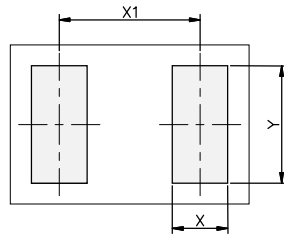
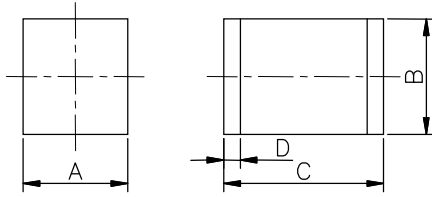

Recommended Soldering Pad Layout

Symbol	Millimeters	Inches
A	1.9±0.2	0.075±0.008
B	2.1±0.2	0.083±0.008
C	2.9±0.3	0.114±0.012
D	0.3±0.1	0.012±0.004
X	0.7	0.028
X1	2.9	0.114
Y	2.3	0.091

### Packaging Information

#### Tape Specifications

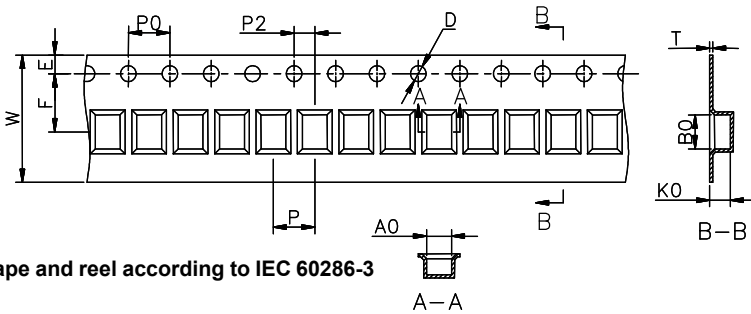

Tape and reel according to IEC 60286-3

#### Reel Specifications

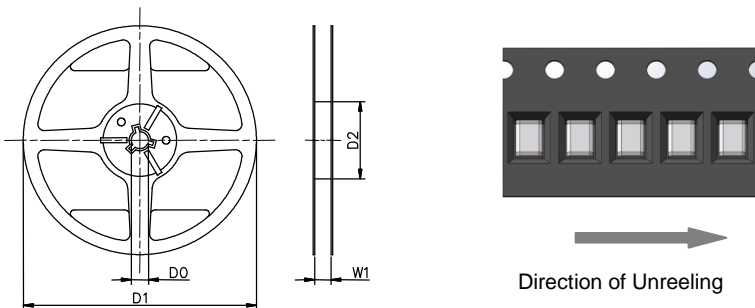

Symbol	Millimeters	Inches
W	12±0.3	0.472±0.012
A0	2.4±0.1	0.094±0.004
B0	3.2±0.1	0.126±0.004
K0	2.0±0.1	0.079±0.004
P	4.0±0.1	0.157±0.004
F	5.5±0.1	0.217±0.004
E	1.75±0.1	0.069±0.004
D	1.5+0.1/-0.0	0.059+0.004/-0.0
P0	4±0.1	0.157±0.004
P2	2±0.1	0.079±0.004
T	0.3±0.05	0.012±0.002
D0	13.3±0.15	0.524±0.006
D1	178±2	7.007±0.079
D2	60+1/-2	2.362+0.039/-0.079
W1	12.5±0.4	0.492±0.016

#### Packaging Quantity:

- 2,000 PCS per reel (7")
- 4 reels per inner box
- 8,000 PCS per inner box

## Gas Discharge Tubes (GDT)

## SMD2921 Series

### Soldering Parameters - Reflow Soldering (Surface Mount Devices)

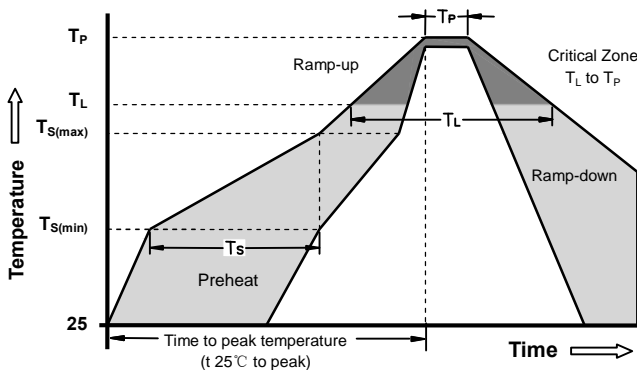

Reflow Condition		Pb - Free assembly
<b>Preheat</b>	-Temperature Min ( $T_{s(min)}$ )	150°C
	-Temperature Max ( $T_{s(max)}$ )	200°C
	- Time (min to max) ( $t_s$ )	60 - 180 Seconds
<b>Average ramp up rate ( Liquids Temp <math>T_L</math>) to peak</b>		3°C/second max
<b><math>T_{s(max)}</math> to <math>T_L</math> - Ramp-up Rate</b>		5°C/second max
<b>Reflow</b>	- Temperature ( $T_L$ ) (Liquids)	217°C
	- Time (min to max) ( $t_s$ )	60 - 150 Seconds
<b>Peak Temperature (<math>T_P</math>)</b>		260 +0/-5°C
<b>Time within 5°C of actual peak Temperature (<math>t_p</math>)</b>		10 - 30 Seconds

Surface mounted components (SMD) may exhibit a temporary increase in the DC spark-over voltage after the solder reflow process. The components will recover within 24 hours. There is no quality defect nor change in protection levels during the temporary change in DC spark-over voltage.

### Terms and definitions

NO.	Item	Definitions
1	<b>Gas discharge tube(GDT)</b>	A gap, or several gaps, in an enclosed discharge medium, other than air at atmospheric pressure, designed to protect apparatus or personnel, or both, from high transient voltages. Also referred to as "gas tube surge arrester".
2	<b>DC Spark-over Voltage</b>	The voltage at which the gas discharge tube sparks over with slowly increasing d.c. voltage.
3	<b>Impulse Spark-over Voltage</b>	The highest voltage which appears across the terminals of a gas discharge tube in the period between the application of an impulse of given wave-shape and the time when current begins to flow.
5	<b>Arc voltage</b>	Voltage drop across the GDT during arc current flow.
6	<b>Glow voltage</b>	Peak value of voltage drop across the GDT when a glow current is flowing.
7	<b>Impulse discharge current 8/20µs</b>	Current impulse with a nominal virtual front time of 8 µs and a nominal time to half-value of 20 µs.
8	<b>Alternating Discharge Current</b>	The rms value of an approximately sinusoidal alternating current passing through the gas discharge tube.
9	<b>Insulation Resistance</b>	Insulation resistance shall be measured from each terminal to every other terminal of the GDT. The test is performed with DC50V when normal spark-over Voltage 70~150V, others with DC100V.
10	<b>Capacitance</b>	The capacitance shall be measured once at 1 MHz between all terminals unless otherwise specified.

**Cautions and warnings**

- I Do not operate surge arresters in power supply networks, whose maximum operating voltage exceeds the minimum spark-over voltage of the surge arresters.
- I Surge arresters may become hot in the event of longer periods of current stress (burn risk). In the event of overload the connectors may fail or the component may be destroyed.
- I Surge arresters must be handled with care and must not be dropped.
- I Do not continue to use damaged surge arresters.
- I The shown SMD pad dimensions represent a safe way to mount the arrester and are a recommendation of the manufacturer. During the reflow process it must be assured that no solder material reduces the insulation distance between the pads below the arrester.
- I SMD surge arresters should be soldered within 24 month after shipment.